



DAV POLICE PUBLIC SCHOOL
FATEHABAD



Holidays Homework(2024-25)

Nursery

Name : _____



Summer is messy,
Summer is fun,
Trips to the beach,
In the hot, hot Sun,
Let's give summer,
A big fat cheer!
Summer is the best time of the year.

Dear Parent,

Children are born with natural curiosity and inquisitiveness about the world around them. It is important for us to help them keep this spark alive and to make learning fun.

Summer Vacation is just round the corner, let every moment of this vacation be a time to unite, connect and enjoy beautiful moments with your child.

Here are some activities given to help your child become independent and confident:-

Independent Me

- Buttoning and Unbuttoning
- Put on your Socks and Shoes
- Keeping belongings back in their place
- Filling the water bottles
- Keeping room clean and well-organized
- Tear a Chapati and eat your Meal on your own

Alone we can do so little; together we can do so much. (Social Skills)

- Wish your elders with a smile
- Go outdoors and play with your friends
- Use magical words: Sorry, Please, Excuse Me, Thank You

One, who maintains cleanliness, keeps away diseases. (Personal Hygiene)

- Brushing teeth twice a day.
- Combing hair regularly
- Bathing everyday
- Washing hands before and after meals.

Reading is Fun

Children are made readers on the laps of their parents.

- Make reading a regular practice with pictures and large text.
- Make bed-time stories a part of your child's daily routine.

The teachers are trying to encourage the children to use simple words , phrases and sentences in school and at home like.



ALL ABOUT ME

- What is your name?
- How old are you?
- In which class do you read?
 - What is the name of your school?
 - What is the name of your teacher?
 - What is your father and mother name?
- May I come in ma'am?
- May I Drink water?
- May I go to the toilet?
- I am feeling hungry.
- Please give me a glass of water.
- Please trim my nails.
- Please tell me a story.
- I am feeling sleepy.

COLOUR THE PICTURES

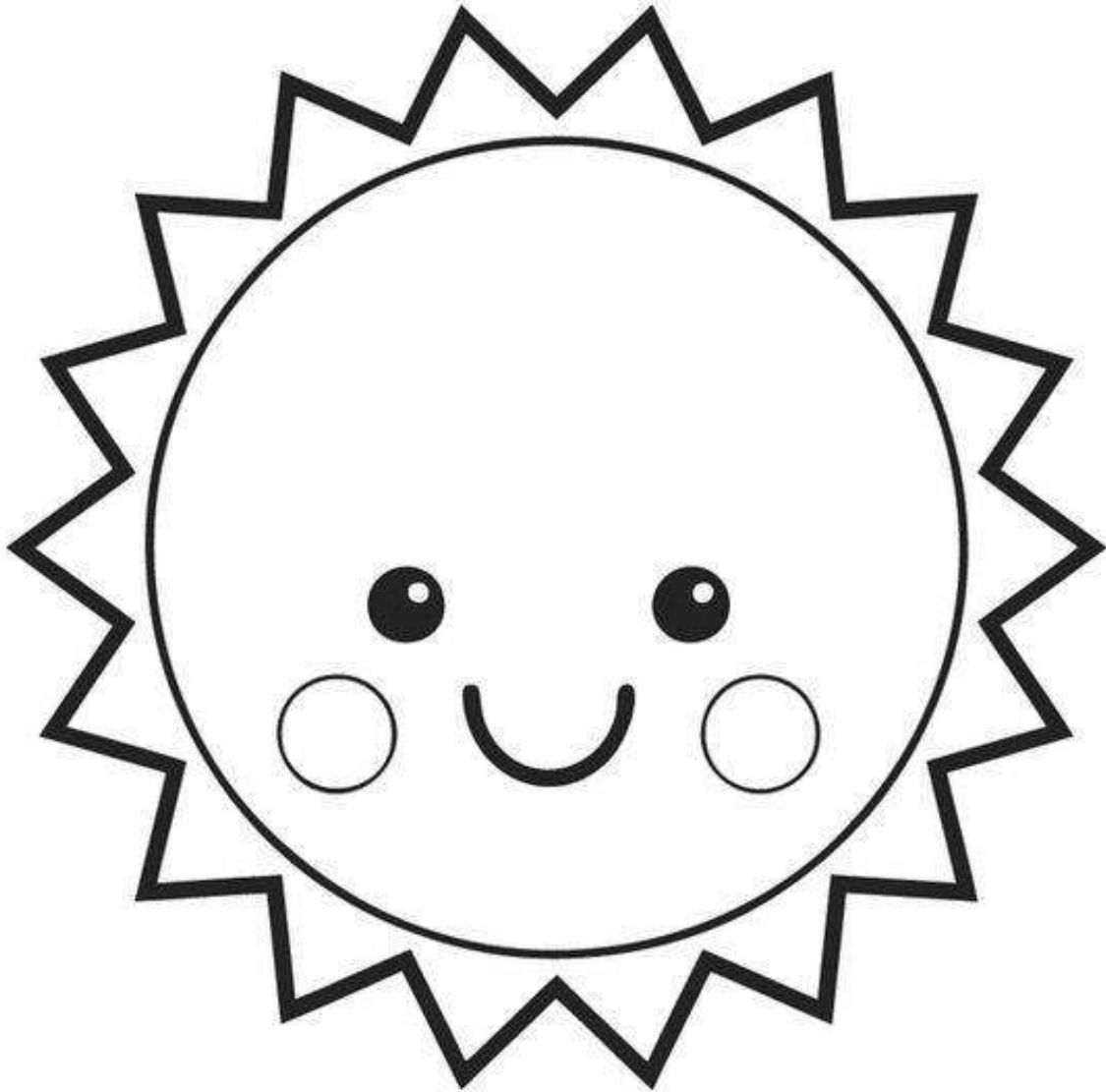

SPRING

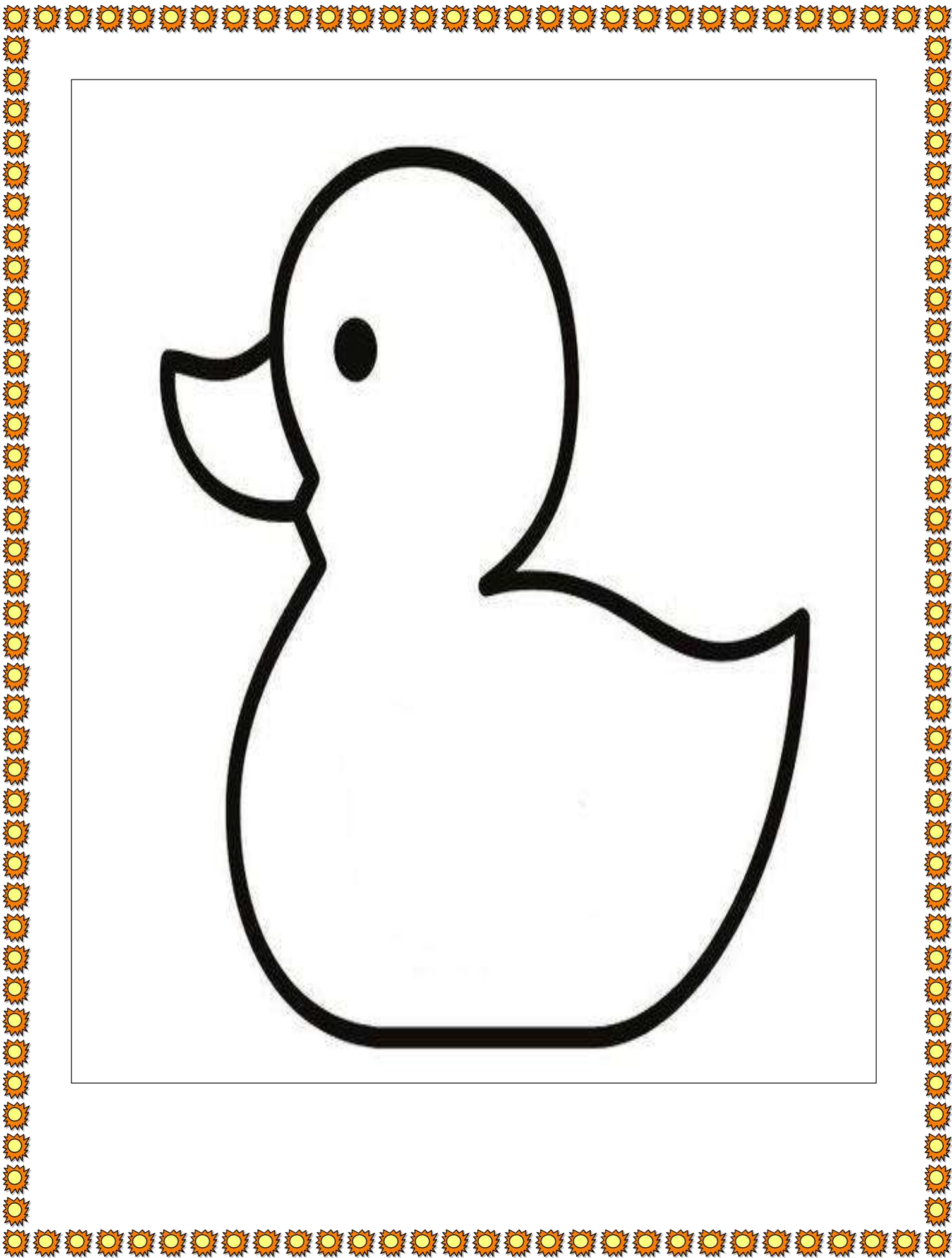

SUBJECT: ENGLISH
WORKSHEET NO. 1



Tracing Practice II

Directions: Trace the lines in each row.



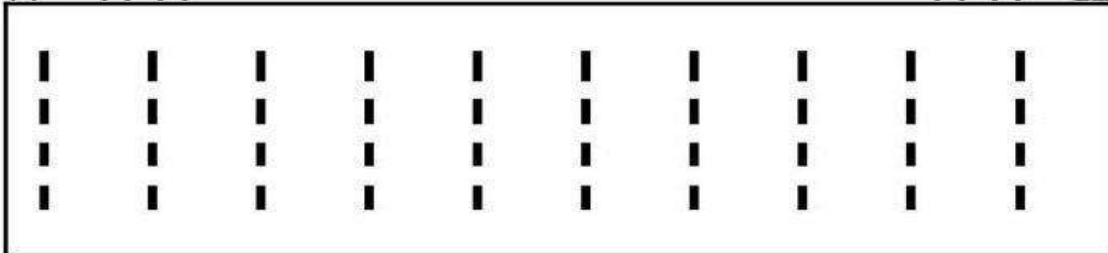
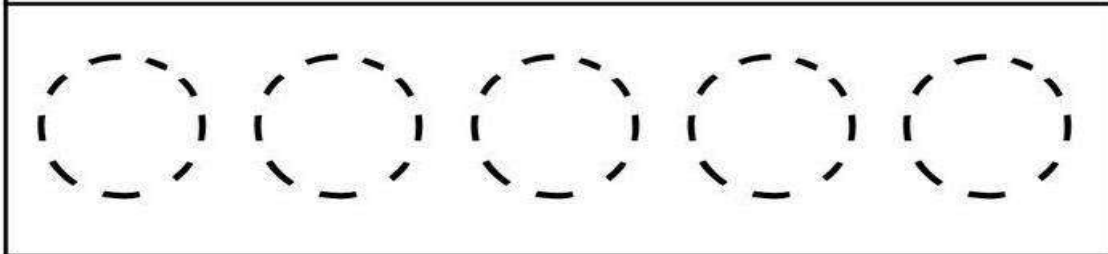
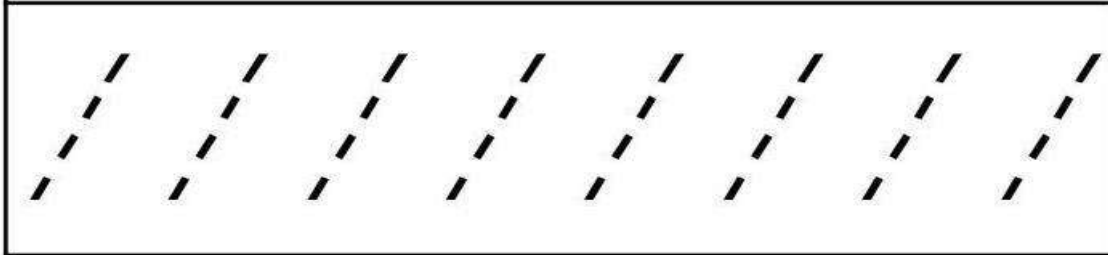
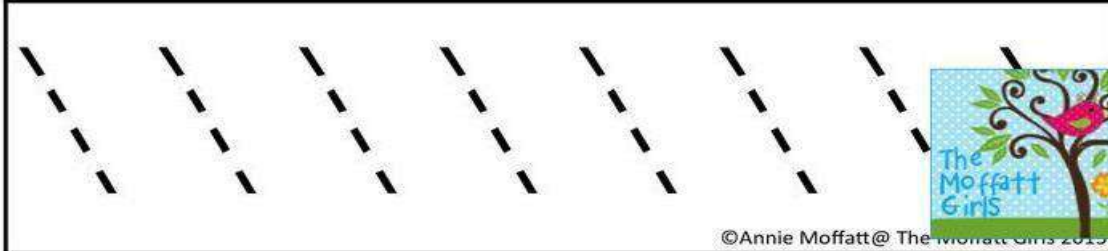

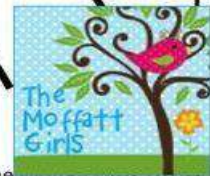





WORKSHEET NO. 2

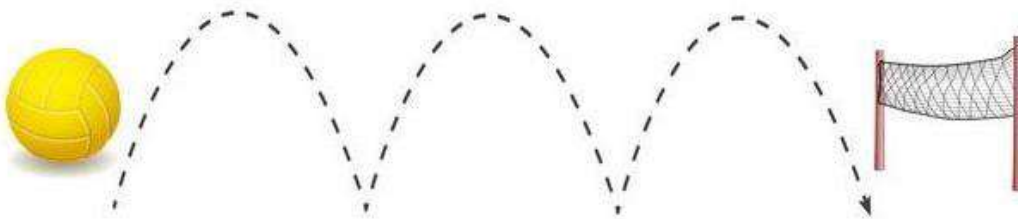
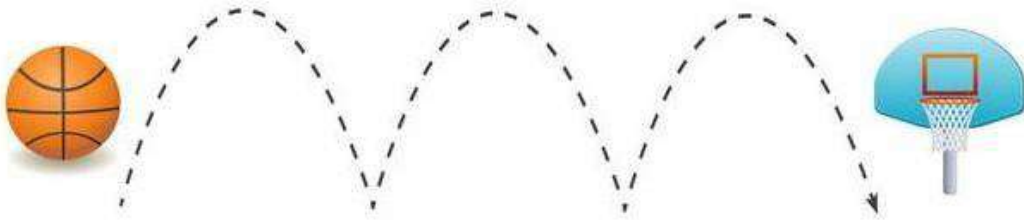

Let's score a point! Help the balls reach their goals by tracing the curved lines from left to right.



WORKSHEET NO. 3



Circle the letter 'A'

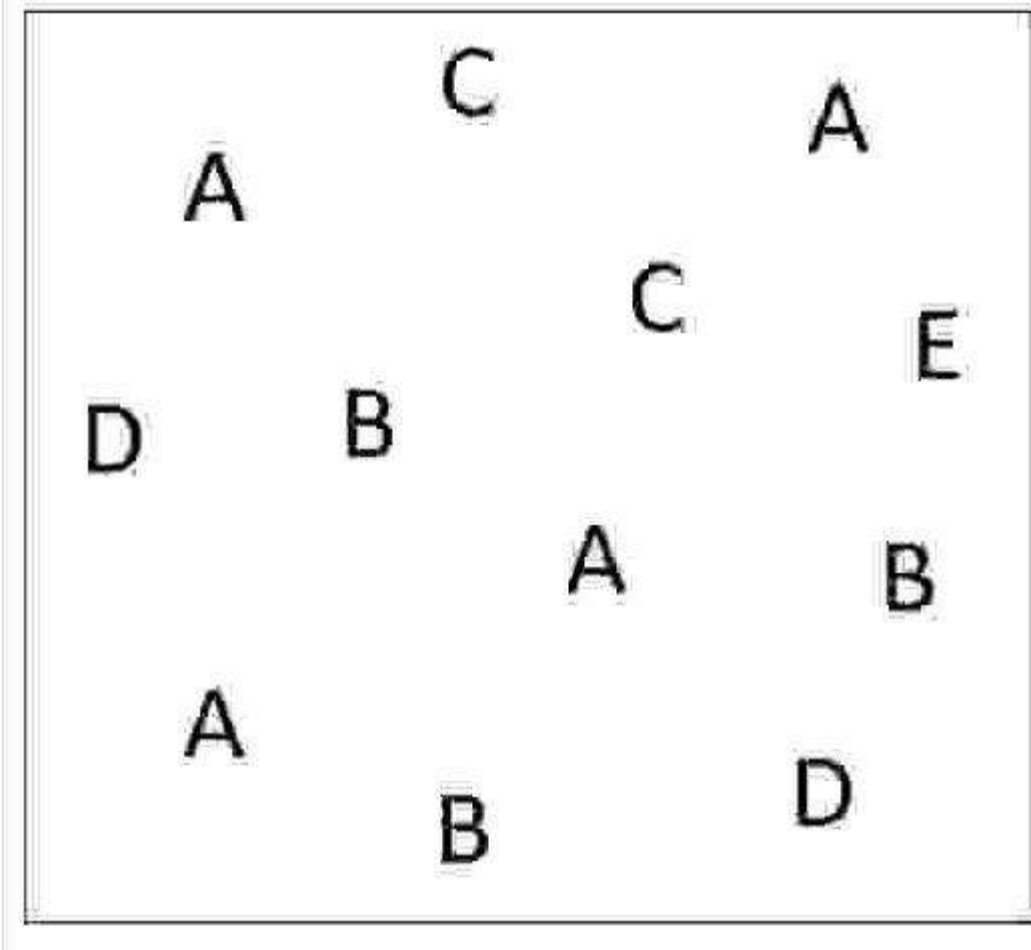

WORKSHEET NO. 4

Color the picture

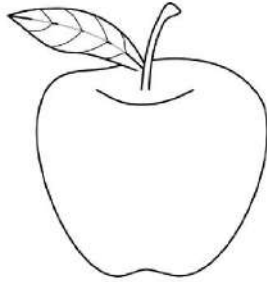

Apple



Ant



Alligator

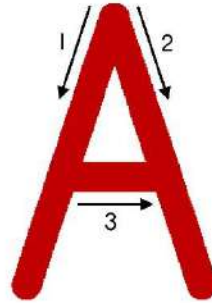

Trace the letter

NOTE:

Write 2 pages of each (Standing line ,Sleeping line, Slanting line and letters A to D.

SUBJECT: MATHS
WORKSHEET NO. 1

Colour the big ball

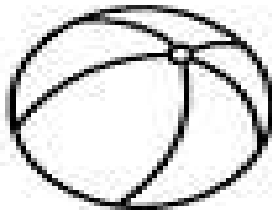
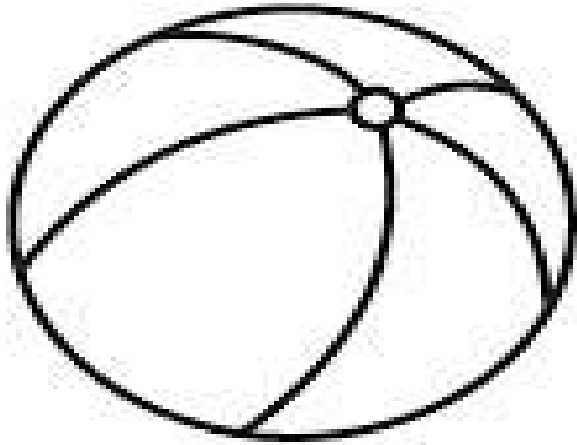

WORKSHEET NO. 2

Color the short toothpaste.

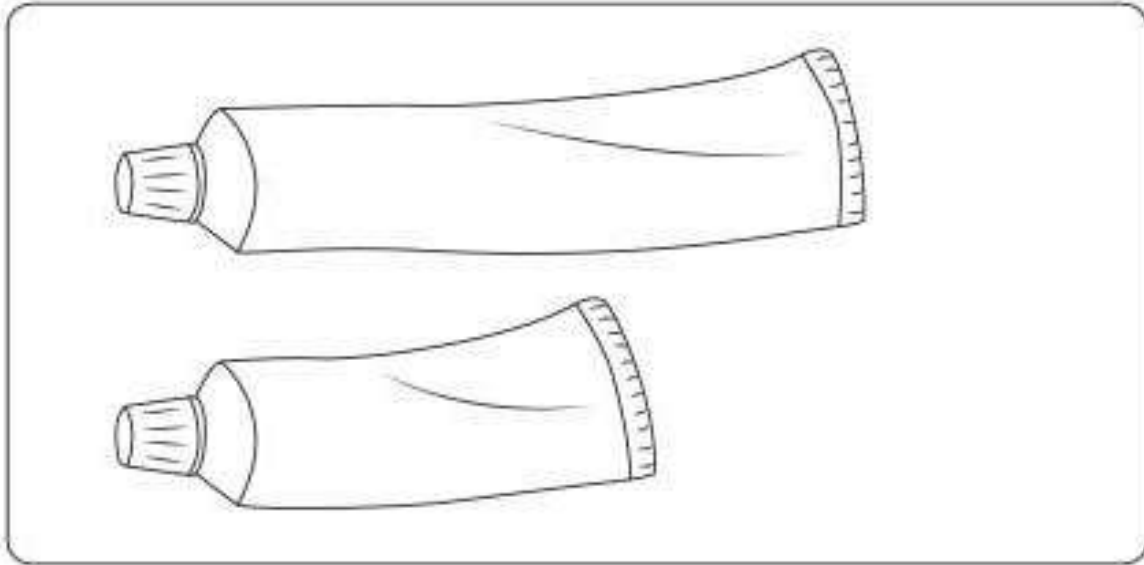

Color the long toothbrush.

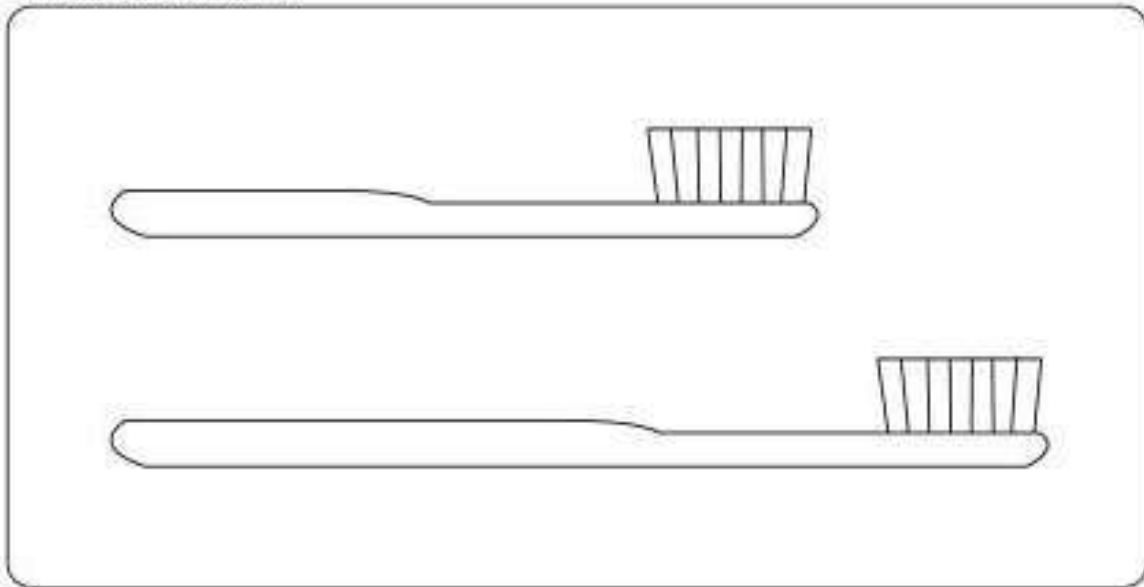

Worksheet No.-3

Match the Same Objects

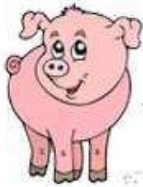

ACTIVITIES:

Activity:1-

ENGLISH-Paste any two pictures related letter A on A4 sheet.

Activity:2

MATHS-Use your Creativity and make an object which is Square in shape and decorate it.

Such as:

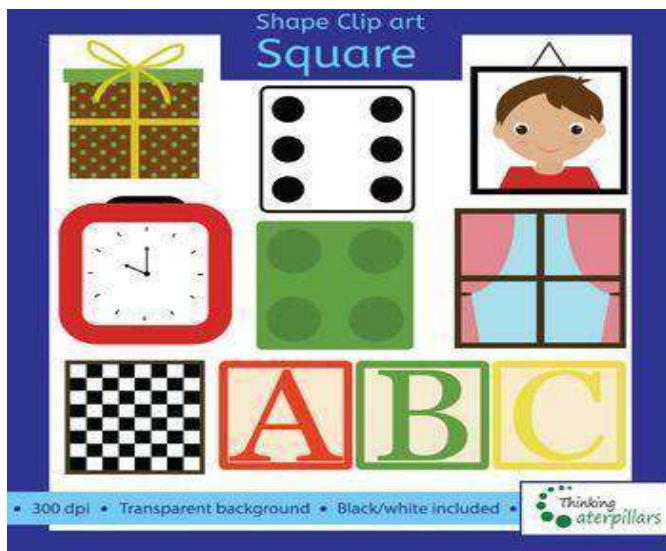

Activity:3

EVS-Use your creativity and help your child to make any 1 Fruit of his/her choice on A4 size sheet.

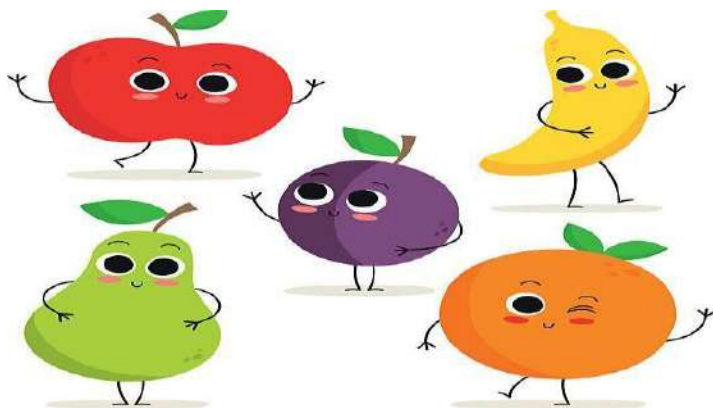

LET'S GO.....



Plan a trip or one-day trip.



Paste the photograph of your family on a Colourful A4 size sheet.



Paste the photographs of the places you visited.



Paste the photographs of the different things you saw there. *Help your child to make it beautiful.



Let your child watch any of the movie in the vacation.







1. 'CHARLIE AND THE CHOCOLATE FACTORY'.

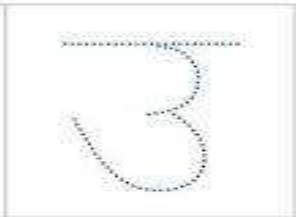
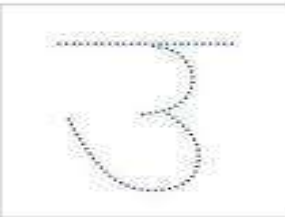

उ

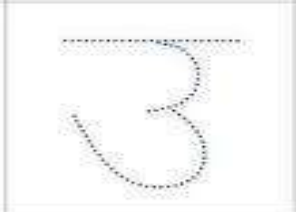

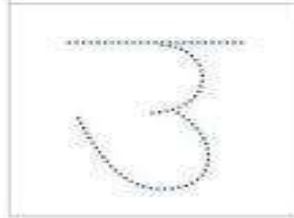
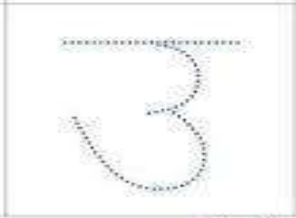
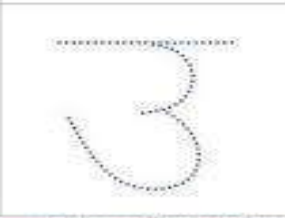
<http://www.webtools.services/letter-tracing-worksheets>

Name:.....

Date:.....

उ - (U)

U as in put



उल्लू
Ulluu
(Owl)

Steps to write the letter "उ"

1	2	3	4		
---	---	---	---	--	--

उ उ उ उ उ उ उ

उ उ उ उ उ उ उ

Blank handwriting practice row

Blank handwriting practice row

Blank handwriting practice row

Blank handwriting practice row

Have a great



VaCation!